

Standard Scratch Off Areas

(Custom Shapes & Sizes can be custom quoted)

1" Gold Circle

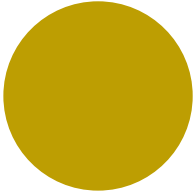

1" Silver Circle

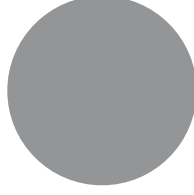

2" x 1" Gold Rectangle



2" x 1" Silver Rectangle



1" Holographic Circle



2" x 1" Holographic Rectangle

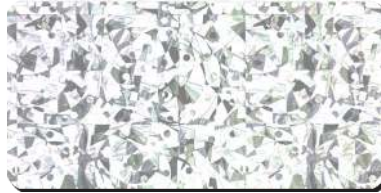

1" Holographic Square



1" Gold Square

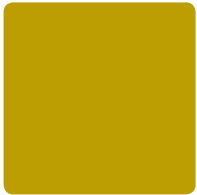

1" Silver Square



1.5" x .3875"

in

Silver

Zebra

Holographic



3.5" x 2" Scratch off specs

Size: 3.75" x 2.25" trims to 3.5" x 2"

Colors: Full Color BOTH Sides (CMYK)

Paper: 12 point Coated both side with Premium UV Gloss on front only

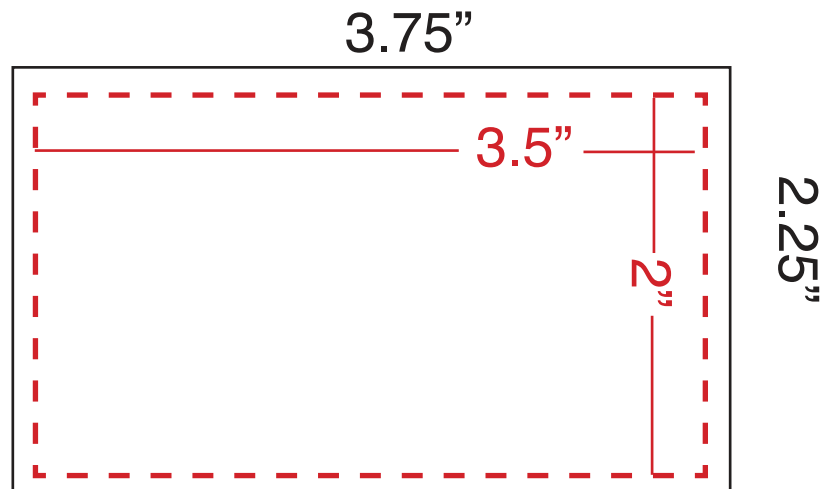

**Small Phone Card Specs
(3.375" x 4.875")**

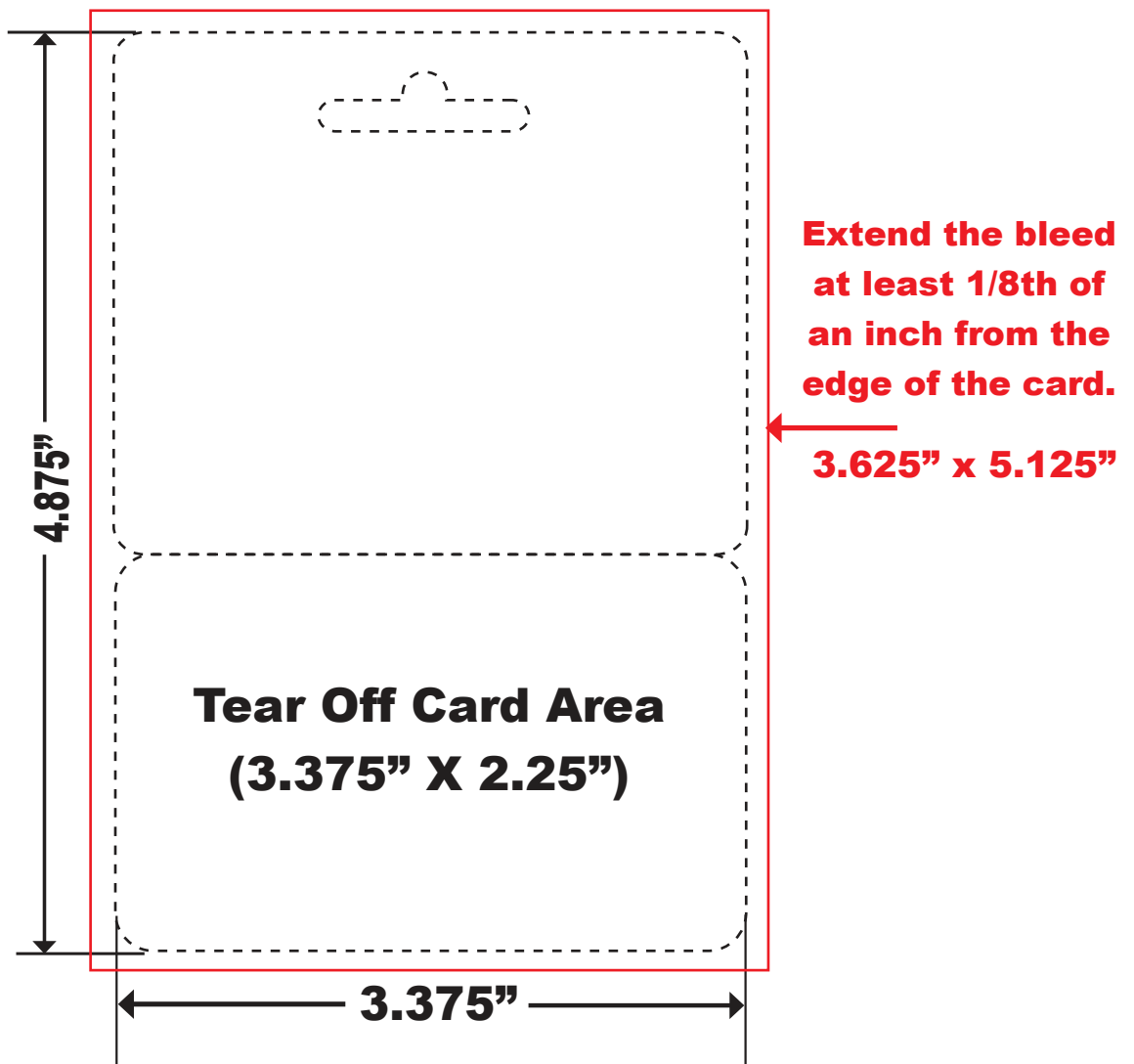

**Long Phone Card Specs
(3.5" x 7.375")**

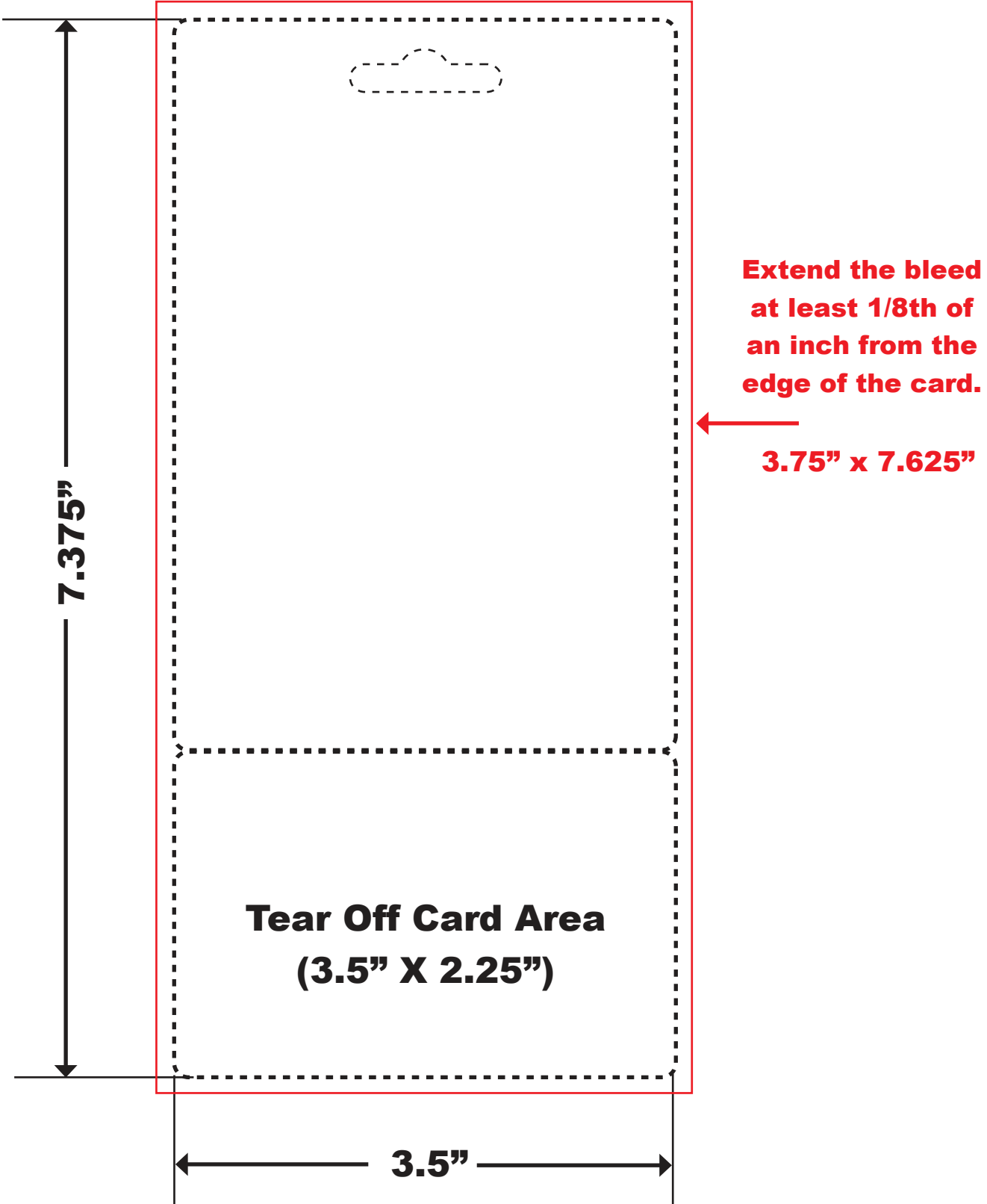

Scratch off Areas

1" Circle (Gold or Silver)



White knockout must be .8" in diameter to be completely covered by a 1" scratch off circle. (Can be placed anywhere on card, but at least 1/8th inch from the bleed) Prizes are inkjetted. Maximum 2 lines of type, 12 characters

1" Square (Gold or Silver)

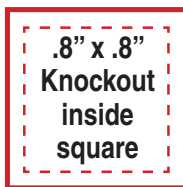

White knockout must be .8" x .8" to be completely covered by a 1" x 1" scratch off square. (Can be placed anywhere on card, but at least 1/8th inch from the bleed) Prizes are inkjetted. Maximum 2 lines of type, up to 12 characters each, including spaces.

1.5625" x .3125" Rectangle



White knockout must be 1.25" x .1875" to be completely covered by a 1.5625" x .3125" scratch off rectangle. (Can be placed anywhere on card, but at least 1/8th inch from the bleed) Prizes are inkjetted. Maximum 1 line of type, up to 20 characters, including spaces.

2" x 1" Rectangle

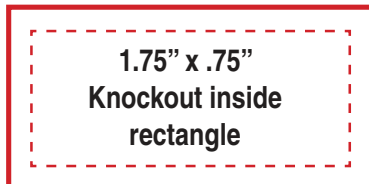

White knockout must be 1.75" x .75" to be completely covered by a 2" x 1" scratch off rectangle. (Can be placed anywhere on card, but at least 1/8th inch from the bleed) Prizes are inkjetted. Maximum 2 lines of type, up to 20 characters each, including spaces.



Promo Printing Group, Inc.

5133 W. Cypress St. • Tampa, FL 33607

Local: 813-831-9902 • Fax: 813-831-9903 • Toll Free: 866-831-9902

info@promoprintinggroup.com

General Art Specifications

Promo Printing works primarily on a MAC based platform. However, can accept PC files as PDF, EPS, and TIF. Please call us toll free to discuss your options or email us at steve@promoprintinggroup.com

For your order to go smoothly, please read the following artwork specifications. If you are not a designer and have hired a third party to do your design work, please make sure that they have a copy of this page before they start working on your design.

- All phone cards are printed CMYK (4 color process) on front & back.
- All colors must be converted to CMYK prior to submission. Any author's alterations that have to be made at this end will be billed at an hourly rate of \$75.00 per hour with a minimum charge of \$25.00.
- We can not accept any JPEG or GIF Files unless they are 300dpi.
- Name your file the same name as your company.

Acceptable Media Formats:

- CD Rom - Mac
- Email art to steve@promoprintinggroup.com
- Upload your files from our website: www.PromoPrintingGroup.com

Acceptable Programs and Files:

Adobe Photoshop Creative Suite or below (flatten image and convert to Tif, EPS or pdf)
Adobe Illustrator Creative Suite or below
(convert fonts to outlines, embed CMYK images and submit as EPS)
Adobe In-Design Creative Suite or below*

Layout Specifications:

- All artwork must include a 1/8th inch bleed. (For example a 3.375" x 4.875" phone card would be set up as 3.625 x 5.125" or a 3.5" x 7.375" phone card would be set up as 3.75" x 7.625".)
- Do not include crop marks.
- All images should be 300 dpi at 100%
- Keep all text and important images at least 1/8" - 1/4" from the edge of the card.

Please contact Steve with any questions at TOLL FREE 1-866-831-9902.



Promo Printing Group, Inc.

5133 W. Cypress St. • Tampa, FL 33607

Local: 813-831-9902 • Fax: 813-831-9903 • Toll Free: 866-831-9902

info@promoprintinggroup.com